

# Load**LIFTER** 5000™ **ULTIMATE**

ADJUSTABLE AIR HELPER SPRINGS

TOW AND HAUL WITH SAFETY AND COMFORT™



Kit Number

**88339**

## INSTALLATION GUIDE

For maximum effectiveness and safety, please read these instructions completely before proceeding with installation.

*Failure to read these instructions can result in an incorrect installation.*

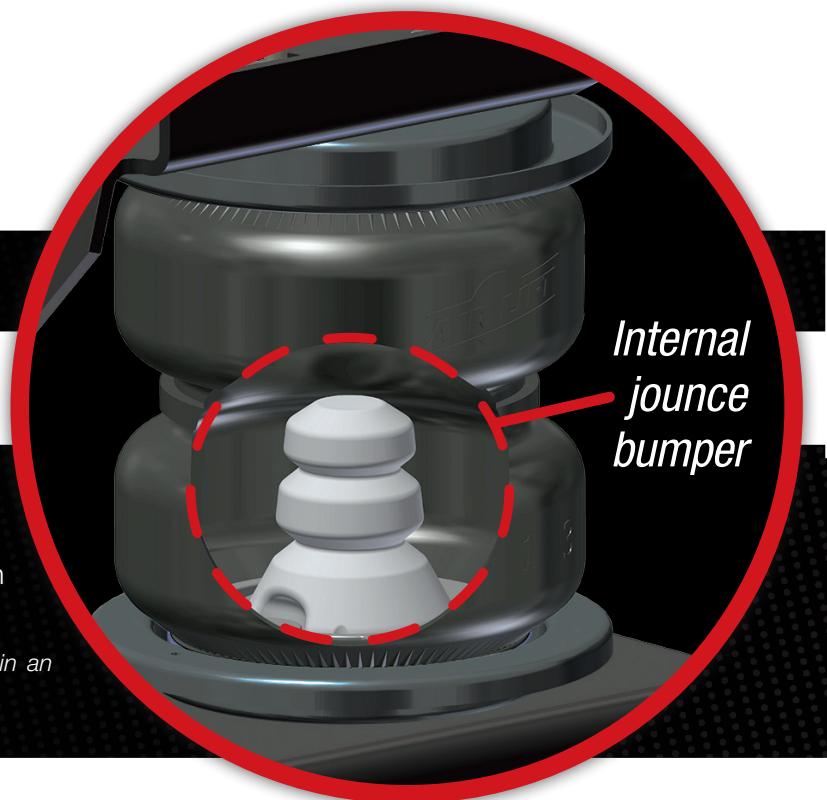



# TABLE OF CONTENTS

<b>Introduction</b> . . . . .	<b>2</b>
Important Safety Notice . . . . .	2
Notation Explanation . . . . .	2
<b>Installation Diagram</b> . . . . .	<b>3</b>
Hardware List . . . . .	4
Tools List . . . . .	4
<b>Installing the LoadLifter 5000 Ultimate System</b> . . . . .	<b>5</b>
Getting Started . . . . .	5
Assembling the Air Springs . . . . .	6
Installing the Assemblies . . . . .	8
Installing the Air Lines . . . . .	12
Installing the Heat Shield . . . . .	14
Checking for Leaks . . . . .	15
Fixing Leaks . . . . .	15
<b>Before Operating</b> . . . . .	<b>16</b>
Installation Checklist . . . . .	16
Post-Installation Checklist . . . . .	16
<b>Product Use, Maintenance and Servicing</b> . . . . .	<b>17</b>
Minimum and Maximum Pressure . . . . .	17
Maintenance Guidelines . . . . .	17
Troubleshooting Guide . . . . .	17
Frequently Asked Questions . . . . .	18
Tuning the Air Pressure . . . . .	18
Guidelines for Adding Air . . . . .	19
<b>Choosing the Right On-Board Air Compressor System</b> . . . . .	<b>20</b>
<b>Warranty and Returns Policy</b> . . . . .	<b>24</b>
<b>Replacement Information</b> . . . . .	<b>25</b>
<b>Contact Information</b> . . . . .	<b>25</b>

# Introduction

The purpose of this publication is to assist with the installation, maintenance and troubleshooting of the LoadLifter 5000 Ultimate air spring kit. LoadLifter 5000 Ultimate utilizes sturdy, reinforced, commercial grade single- or double-bellows (depending on the kit). The bellows are manufactured like a tire with layers of rubber and cords that control growth. An internal jounce bumper inside the spring absorbs shock and eliminates harsh jarring on rough roads. The internal jounce bumper replaces the factory bumper and allows the air springs to safely be run at zero air pressure. LoadLifter 5000 Ultimate kits are recommended for most 3/4 and 1 ton pickups and SUVs with leaf springs, and provide up to 5,000 pounds of load-leveling support with air adjustability from 5-100 PSI. The kits are also used in motorhome rear kits and some motorhome fronts where leaf springs are used.

It is important to read and understand the entire installation guide before beginning installation or performing any maintenance, service or repair. The information here includes a hardware list, tool list, step-by-step installation information, maintenance tips, safety information and a troubleshooting guide.

Air Lift Company reserves the right to make changes and improvements to its products and publications at any time. For the latest version of this manual, contact Air Lift Company at (800) 248-0892 or visit our website at [www.airliftcompany.com](http://www.airliftcompany.com).

## IMPORTANT SAFETY NOTICE

The installation of this kit does not alter the Gross Vehicle Weight Rating (GVWR) or payload of the vehicle. Check your vehicle's owner's manual and do not exceed the maximum load listed for your vehicle.

**Gross Vehicle Weight Rating:** The maximum allowable weight of the fully loaded vehicle (including passengers and cargo). This number — along with other weight limits, as well as tire, rim size and inflation pressure data — is shown on the vehicle's Safety Compliance Certification Label.

**Payload:** The combined, maximum allowable weight of cargo and passengers that the vehicle is designed to carry. Payload is GVWR minus the Base Curb Weight.

## NOTATION EXPLANATION

Hazard notations appear in various locations in this publication. Information which is highlighted by one of these notations must be observed to help minimize risk of personal injury or possible improper installation which may render the vehicle unsafe. Notes are used to help emphasize areas of procedural importance and provide helpful suggestions. The following definitions explain the use of these notations as they appear throughout this guide.

 **DANGER**

INDICATES IMMEDIATE HAZARDS WHICH WILL RESULT IN SEVERE PERSONAL INJURY OR DEATH.

 **WARNING**

INDICATES HAZARDS OR UNSAFE PRACTICES WHICH COULD RESULT IN SEVERE PERSONAL INJURY OR DEATH.

 **CAUTION**

INDICATES HAZARDS OR UNSAFE PRACTICES WHICH COULD RESULT IN DAMAGE TO THE MACHINE OR MINOR PERSONAL INJURY.

---

## NOTE

*Indicates a procedure, practice or hint which is important to highlight.*

---

# Installation Diagram

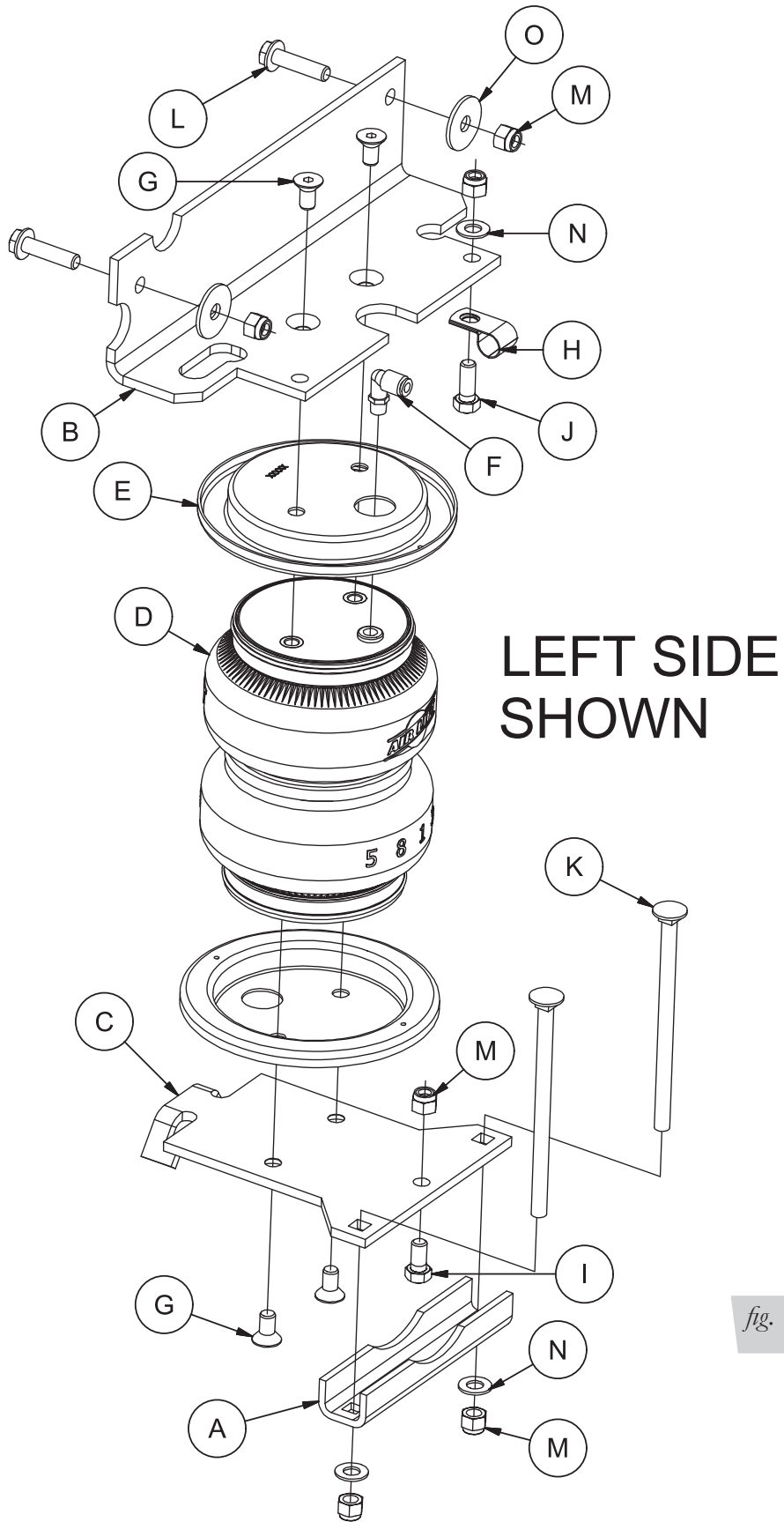

fig. 1

## HARDWARE LIST

Item	Part #	Description.....Qty	Item	Part #	Description.....Qty
A	01531	Clamp bar .....2	M	18435	3/8-16 nyloc nut .....11
B	07043	Upper bracket .....2	N	18444	3/8" flat washer .....6
C	03063	Lower bracket .....2	O	18447	3/8" large flat washer .....4
D	58496	Air spring.....2	P	18501	5/16" flat washer .....8
E	11967	Roll plate.....4	AA*	20086	Air line assembly.....1
F	21837	90° swivel fitting .....2	BB*	10466	Tie strap.....6
G	17215	3/8"-24 x 34" flat head screw .....8	CC*	21230	Valve cap .....2
H	10181	Frame clamp.....1	DD*	18501	5/16" flat washer .....2
I	17101	3/8-16 x 3/4" hex bolt .....2	EE*	21234	Rubber washer.....2
J	17107	3/8-16 x 1" hex bolt .....1	FF*	18411	Star washer.....2
K	17133	3/8"-16 x 6" carriage bolt.....4	GG*	21233	5/16" hex nut.....4
L	17159	3/8"-16 x 1.5" hex flange bolt .....4			

\*Not shown in fig. 1.



Missing or damaged parts? Call Air Lift customer service at (800) 248-0892 for a replacement part.

## TOOLS LIST

Description..... Qty	Description..... Qty
Hoist or floor jacks ..... 1	7/32 allen wrench (socket if available)..... 1
Safety stands..... 2	3/8" and 5/16" drill bits (very sharp)..... 1
Safety glasses ..... 1	Heavy duty drill..... 1
Vise grips..... 2	Hose cutter, razor blade, or sharp knife ..... 1
4" grinder or metal cutting tool..... 1	Air compressor or compressed air source..... 1
Torque wrench..... 1	Spray bottle with dish soap/water solution ..... 1
Standard open-end combo wrenches..... 1	Black paint or undercoating ..... 1
Ratchet ..... 1	
Metric and standard sockets..... 1	

# Installing the LoadLifter 5000 Ultimate System

## GETTING STARTED

 **DANGER**

COMPRESSED AIR CAN CAUSE INJURY AND DAMAGE TO THE VEHICLE AND PARTS IF IT IS NOT HANDLED PROPERLY. FOR YOUR SAFETY, DO NOT TRY TO INFLATE THE AIR SPRINGS UNTIL THEY HAVE BEEN PROPERLY SECURED TO THE VEHICLE.

1. Raise the vehicle and support it using jack stands or equivalent method so that the axle can be dropped safely away from the frame. This will need to be done so the air spring assemblies may be put into position between the axle and frame (fig. 2 shows the frame being supported with the vehicle on a drive-on hoist.).
2. Remove the rear tires and wheels.

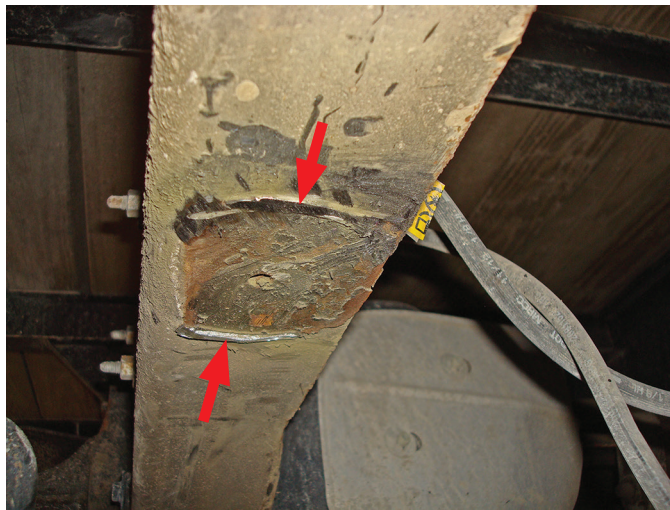

*fig. 2*

3. To install the kit, the stock jounce bumpers must be removed from under the frame rails on both sides. Grind the welds off the jounce bumper cups attaching the jounce bumpers to the frame (fig. 3). Remove and discard the jounce bumpers from both sides of the vehicle. Grind down the welds so they are flush with the frame flange and spray with black spray paint or undercoating (fig. 4).



*fig. 3*



Grind remaining weld flush to the frame flange.

fig. 4

## ASSEMBLING THE AIR SPRINGS

1. Set a roll plate (E) over the top of the bellows (D) (fig. 5).

### NOTE

*The radius (rounded) edge of the roll plate (E) will be towards the air spring, so that the air spring is seated inside both roll plates.*

2. Install the 90° swivel fitting (F) into the top of the bellows, finger tight plus one and a half turns.

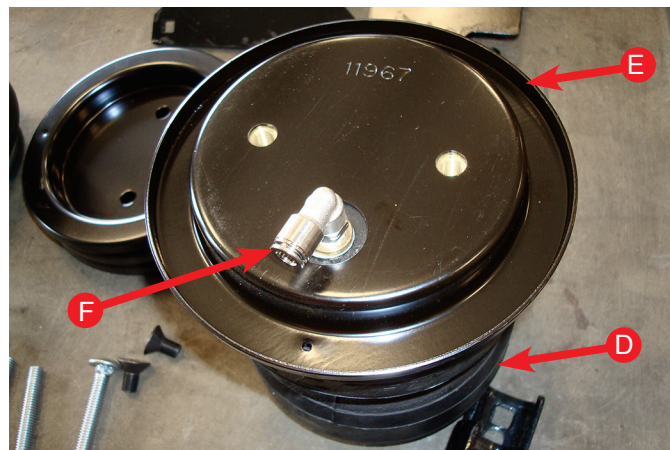

fig. 5

3. Set the upper bracket (B) onto the bellows assembly and attach it with two flat head screws (G) (fig. 6). Torque to no more than 20 ft-lbs. Repeat for both air spring assemblies.

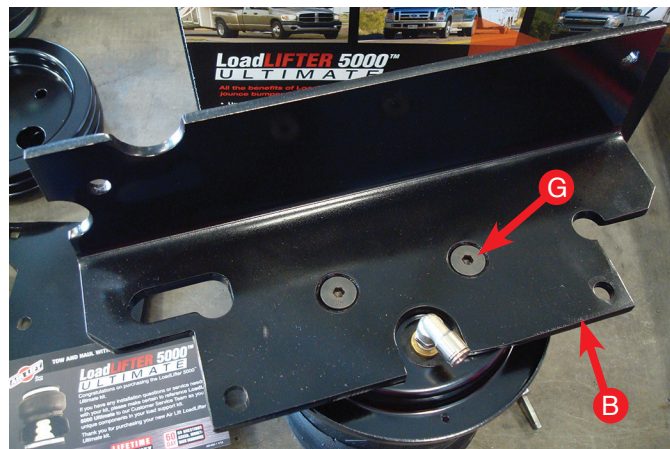
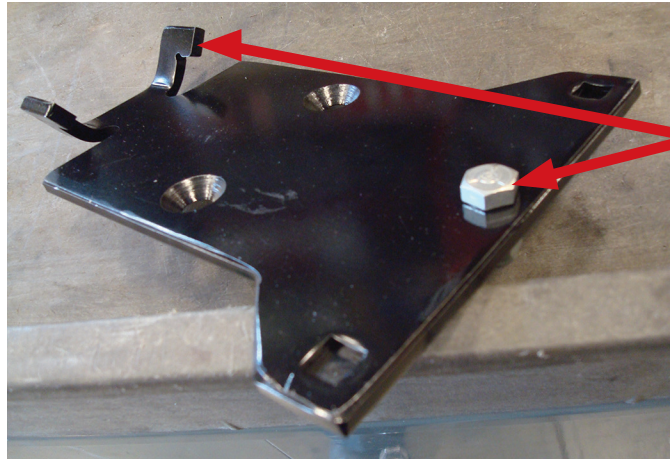

fig. 6



4. Install the 3/8" bolt (I) in the lower bracket (C) making sure the head is on the same side as the flanges are (fig. 7). Cap with a nyloc nut (M) and torque to 20 ft-lbs. Repeat for both lower brackets.



The head of the bolt must be on the same side as the flanges on the lower bracket.

*fig. 7*

5. Set a roll plate over the bottom of the air spring assembly and install the lower bracket making sure the flanges on the lower bracket are on the same side as the flange on the upper bracket (fig. 8). Attach them with two flat head screws (G) and torque to no more than 20 ft-lbs. Repeat for both air spring assemblies.

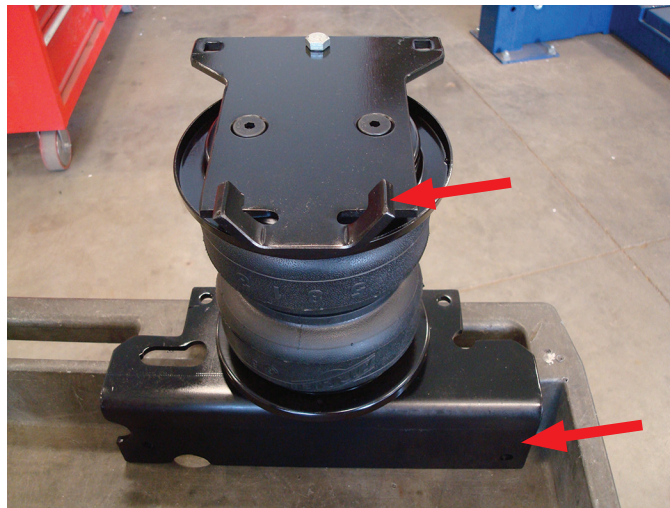

Make sure the flange on the lower bracket is on the same side as the flange on the upper bracket.

*fig. 8*

## INSTALLING THE ASSEMBLIES

1. If you have not already done so, lower the axle down low enough to install the air spring assembly into position between the axle and frame. Set the assembly into position on both sides of the vehicle. The flange on the upper bracket will go on the outside of the frame rail.
2. Push the lower bracket inboard so that the tabs that are on the outside of the lower brackets will index under the jounce bumper strike plate (figs. 9 and 10).

### NOTE

*It may be necessary to bend the tabs on the bracket slightly if they don't line up properly to index under the strike plate.*

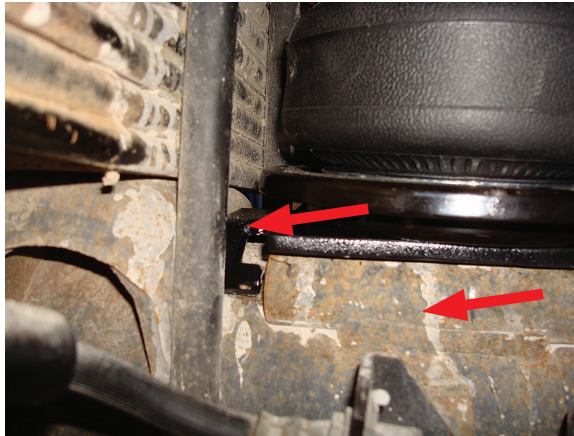

Lower bracket tab inserted under jounce bumper strike plate that is welded onto the axle.

*fig. 9*

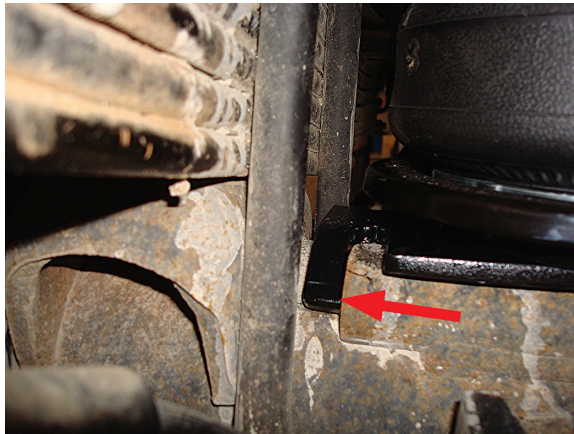

The tabs in the lower bracket shown in position under the jounce bumper strike plate.

*fig. 10*

3. Insert two 3/8" long carriage bolts (K) down through the square holes in the lower bracket and install the clamp bar (A) over them (figs. 1 and 11). Cap with two 3/8" flat washers (N) and two 3/8" nyloc nuts (M). Tighten both evenly to 10 ft-lbs. Repeat for both sides. Figure 12 shows the lower bracket installed on the right (passenger) side.

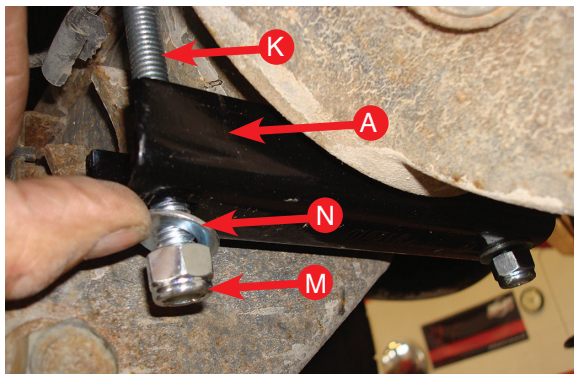

*fig. 11*

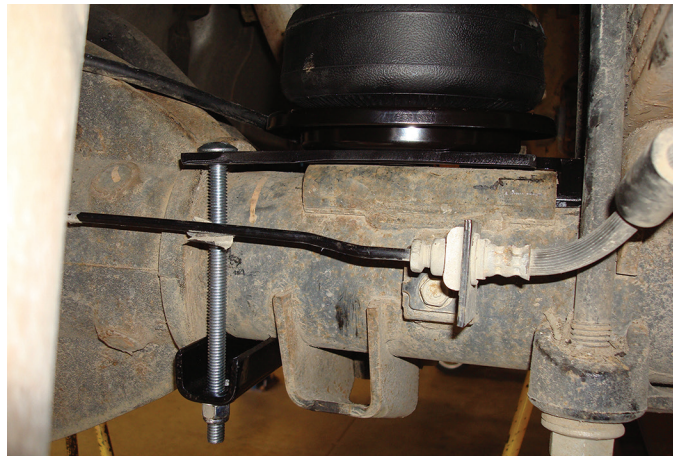

Right (passenger) side lower bracket installation

fig. 12

4. On the inside of the driver side frame above the axle, it will be necessary to unbolt the fuel line holders and pull the fuel lines (if so equipped) away from the frame rail in order to drill the two holes needed to install the upper bracket (fig. 13).

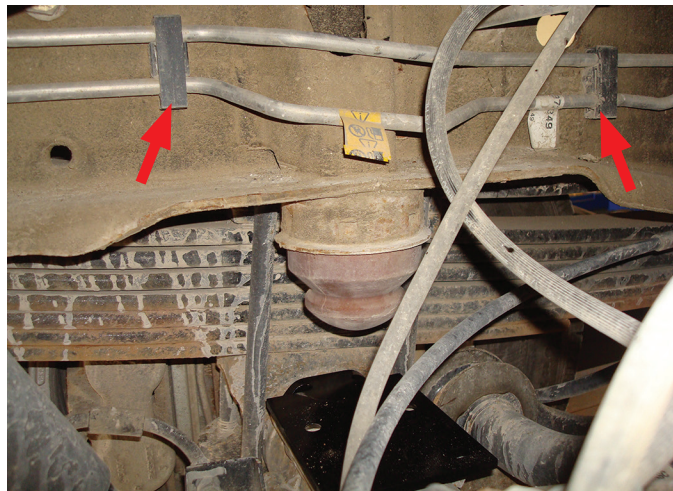

Unbolt and pull the fuel lines away from the frame to gain clearance to drill the holes needed to install the upper bracket.

fig. 13

5. Raise the axle or lower the frame and align the upper bracket on the frame rail so that the air spring is perpendicular to the upper and lower bracket.

## NOTE

*On late model vehicles, there are ABS lines with line holders that may limit this alignment. Align as best you can with these models.*

6. Clamp the flange of the upper bracket to the frame with two sets of vise grips, forward and behind the axle, making sure the upper bracket is flat against the side of the frame rail (fig. 14).

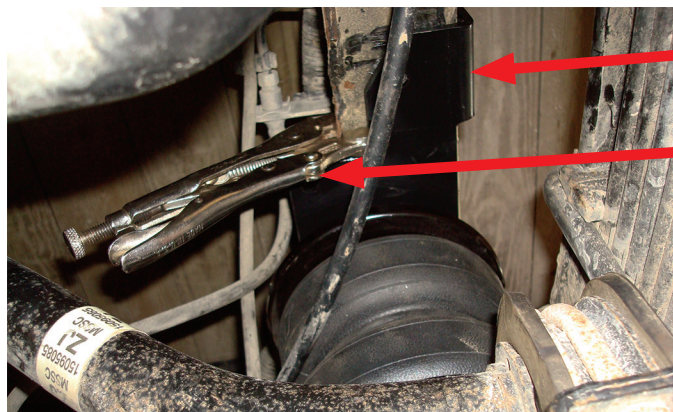

Clamp the bracket to the frame flange with vise grips making sure the side of the bracket is flush against the frame.

fig. 14

## CAUTION

BEFORE DRILLING, CHECK THE BACK-SIDE OF THE FRAME FOR CLEARANCE ISSUES WITH THE BRAKE LINES, GAS LINES, AND ELECTRICAL LINES. ANY OBSTACLES WILL NEED TO BE TEMPORARILY RELOCATED TO CLEAR THE AREA.

7. With the fuel lines previously cleared out of the way on the inside of the left (driver) side frame and using the two holes on the side of the bracket as a template, drill the side of the frame using a 3/8" drill bit (fig. 15).

## NOTE

*It may be necessary to drop the axle slightly to complete step 7.*

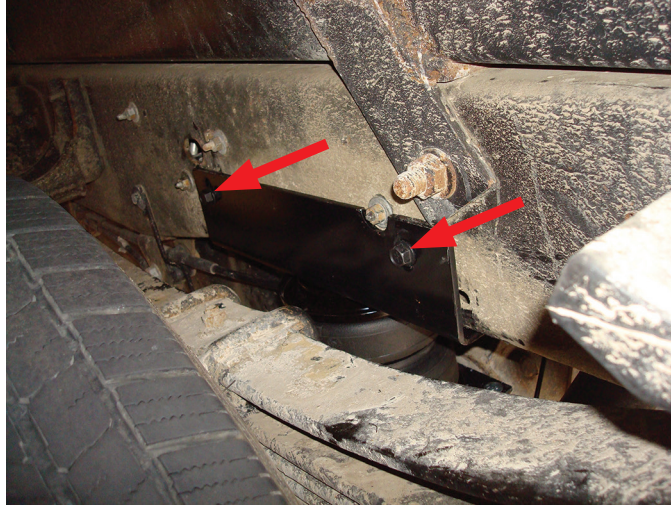

fig. 15

8. Attach the upper bracket to the frame using two 3/8" flange bolts (L), two 3/8" large flat washers (O) and two 3/8" nyloc nuts (M) (figs. 1 and 16). Torque to 44 ft-lbs. Remove vice grips and repeat for the right (passenger) side.

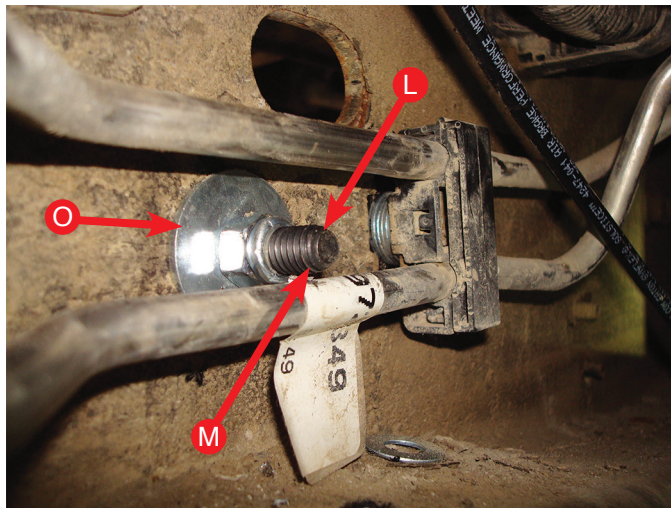
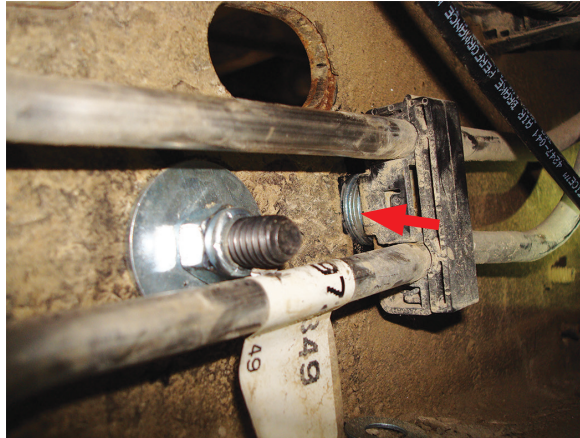

fig. 16

9. Before installing the fuel line rail back on the frame, stack up four 5/16" washers (P) and put them between the fuel line hangers (previously removed) and the frame and insert the studs back through the frame. Cap with the nut originally removed and tighten (fig. 17). This gives extra clearance between bolts and fuel lines to ensure they are not rubbing in any way.

 **CAUTION**

IN NO WAY SHOULD THE BOLTS INSTALLED RUB ON THE FUEL LINES. CORRECT THIS CONDITION BEFORE PROCEEDING WITH THE INSTALLATION.



4 X 5/16" washers (P) stacked up behind line holder's in the front and in the rear of axle.

*fig. 17*

10. Insert the emergency brake cable, on the left (driver) side above the axle, into the P-clamp (H) and install the P-clamp onto the front inside corner hole of the upper bracket as shown in figures 1 and 18 using one 3/8" bolt (J) one 3/8" flat washer (N) and 3/8" nyloc nut (M). Figure 19 shows an alternate installed view.

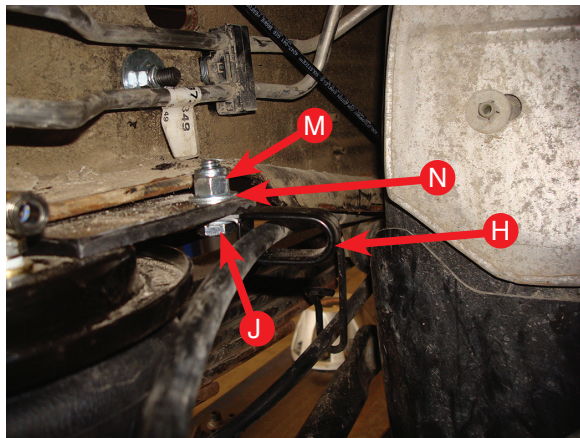

*fig. 18*

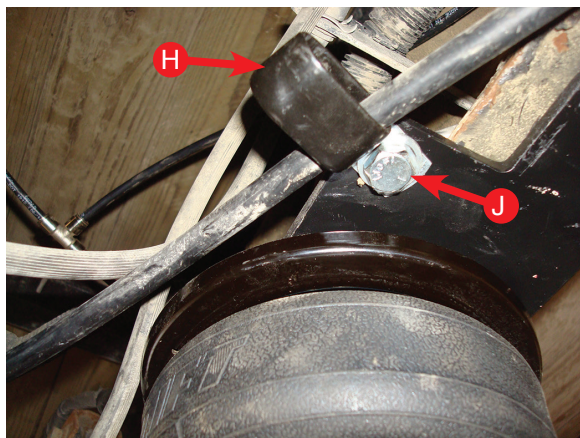

*fig. 19*

## INSTALLING THE AIR LINES

1. Choose a convenient location for mounting the inflation valves. Popular locations for the inflation valve are:
  - a. The wheel well flanges.
  - b. License plate recess in bumper.
  - c. Under the gas cap access door.
  - d. Through license plate itself.

**NOTE**

*Whatever the chosen location is, make sure there is enough clearance around the inflation valves for an air chuck.*

2. Drill a 5/16" hole to install the inflation valves.
3. Cut the air line assembly (AA) in two equal lengths.

**CAUTION**

WHEN CUTTING OR TRIMMING THE AIR LINE, USE A HOSE CUTTER, A RAZOR BLADE OR A SHARP KNIFE. A CLEAN, SQUARE CUT WILL PREVENT LEAKS. DO NOT USE WIRE CUTTERS OR SCISSORS TO CUT THE AIR LINE. THESE TOOLS MAY FLATTEN OR CRIMP THE AIR LINE, CAUSING IT TO LEAK AROUND THE O-RING SEAL INSIDE THE ELBOW FITTING (FIG. 20).

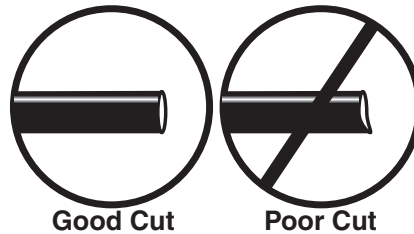
*fig. 20*

4. After cutting the hose to length on the passenger side, slide the hose heat shield over the air line before inserting into the fitting. Using a tie strap, tie it to the front inside hole in the upper bracket as shown in figure 21.

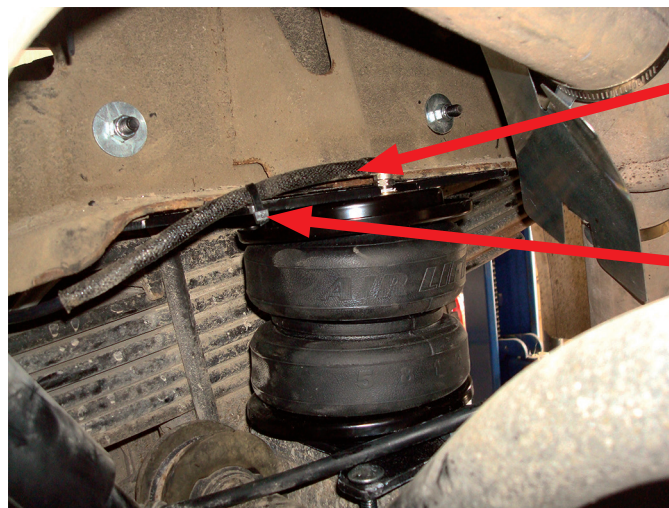

Hose heat shield

Tie strapped to the upper bracket using the existing hole.

*fig. 21*

- Place a 5/16" hex nut (GG) and a star washer (FF) on the air valve. Leave enough of the inflation valve in front of the nut to extend through the hole and have room for the rubber washer (EE), flat washer (DD), and 5/16" hex nut (GG) and valve cap (CC). There should be enough valve exposed after installation - approximately 1/2" - to easily apply a pressure gauge or an air chuck (fig. 22).
- Push the inflation valve through the hole and use the rubber washer (EE), flat washer (DD), and another 5/16" hex nut (GG). Tighten the nuts to secure the assembly in place (fig. 22).

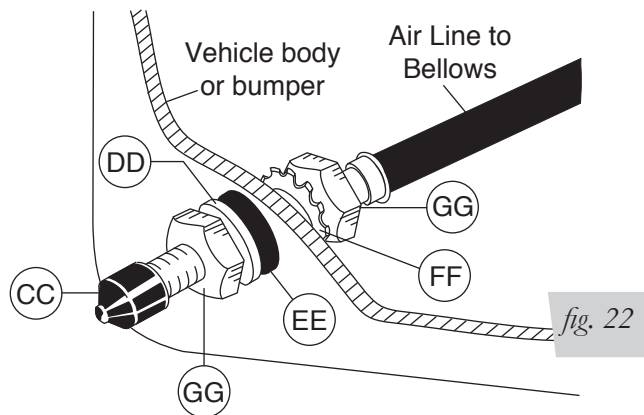

- Route the air line along the frame to the air fitting on the air spring (fig. 23). Keep AT LEAST 6" of clearance between the air line and heat sources, such as the exhaust pipes, muffler, or catalytic converter. Avoid sharp bends and edges. Use the plastic tie straps (BB) to secure the air line to fixed, non-moving points along the chassis. Be sure that the tie straps are tight, but do not pinch the air line. Leave at least 2" of slack to allow for any movement that might pull on the air line.

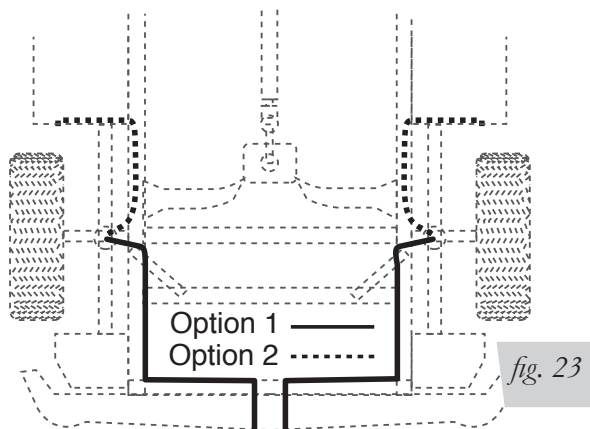

- Cut off air line, leaving approximately 12" of extra air line. A clean square cut will ensure that the line will not leak (see fig. 20). Insert the air line into the air fitting. This is a push-to-connect fitting. Simply push the air line into the 90° swivel fitting until it bottoms out (9/16" of air line should be in the fitting).

## INSTALLING THE HEAT SHIELD

**NOTE**

*Finished photo of heat shield installed on right-side (passenger) exhaust (Fig. 24).*



*fig. 24*

1. Bend the tabs on the heat shield to provide a 1/2" dead air space between exhaust pipe and heat shield (fig. 25).

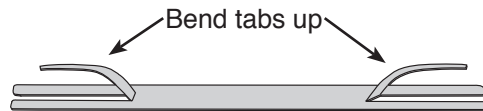

*fig. 25*

2. Attach the heat shield to the exhaust pipe using the clamps (fig. 26). Bend the heat shield for maximum clearance to the air spring.

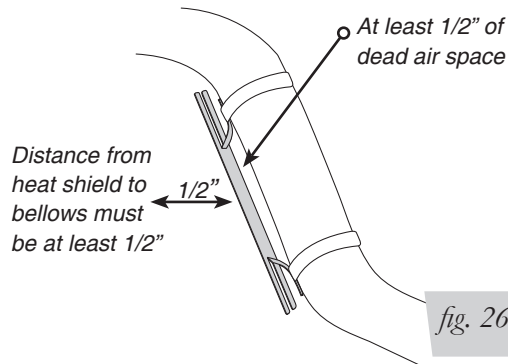

*fig. 26*

## FINISHING UP THE INSTALLATION

1. Re-attach the tires back onto the vehicle and torque lug nuts to the manufacture's torque specifications.
2. Remove the jack stands or equivalent.



## CHECKING FOR LEAKS

1. Inflate the air spring to 30 PSI and spray all connections and the inflation valves with a solution of 1/5 liquid dish soap and 4/5 water to check for leaks. Spot leaks easily by looking for bubbles in the soapy water.
2. After the test, deflate the springs to the minimum pressure required to restore the normal ride height, no less than 5 PSI.
3. Check the air pressure again after 24 hours. A 2-4 PSI loss after initial installation is normal. Retest for leaks if the loss is more than 5 lbs.

## FIXING LEAKS

1. If there is a problem with the swivel fitting:
  - a. Check the air line connection by deflating the spring and removing the line by pulling the collar against the fitting and pulling firmly on the air line. Trim 1" off the end of the air line. Be sure the cut is clean and square (see fig. 20). Reinsert the air line into the push-to-connect fitting.
  - b. Check the threaded connection by tightening the swivel fitting another 1/2 turn. If it still leaks, deflate the air spring, remove the fitting, and re-coat the threads with thread sealant. Reinstall by hand tightening as much as possible, then use a wrench for an additional two turns.
2. If there is a problem with the inflation valve, then:
  - a. Check the valve core by tightening it with a valve core tool.
  - b. Check the air line connection by removing the air line from the barbed type fitting.



### CAUTION

DO NOT CUT THE AIR LINE COMPLETELY OFF AS THIS WILL NICK THE BARB AND RENDER THE FITTING USELESS.

3. If the preceding steps have not resolved the problem, call Air Lift customer service at (800) 248-0892 for assistance.

# Before Operating

## INSTALLATION CHECKLIST (To be completed by installer)

- Clearance test — Inflate the air springs to 60 PSI and ensure there is at least 1/2" clearance around each bellow, away from anything that might rub against them. Be sure to check the tire, brake drum, frame, shock absorbers and brake cables.
- Leak test before road test — Inflate the air springs to 60 PSI, check all connections for leaks with a soapy water solution. See the *Checking for Leaks* section for tips on how to spot leaks. All leaks must be eliminated before the vehicle is road tested.
- Heat test — Be sure there is sufficient clearance from any heat sources — at least 6" for air springs and air lines. If a heat shield was included in the kit, install it. If there is no heat shield, but one is required, call (800) 248-0892.
- Fastener test — Recheck all bolts for proper torque. Retorque after 100 miles.
- Road test — The vehicle should be road tested after the preceding tests. Inflate the air springs to 25 PSI (50 PSI if the vehicle is loaded). Drive the vehicle 10 miles and recheck for clearance, loose fasteners and air leaks.
- Operating instructions — If professionally installed, the installer should review the *Product Use, Maintenance and Servicing* section with the owner. Be sure to provide the owner with all of the paperwork which came with the kit.

**Technician's Signature** \_\_\_\_\_

**Date** \_\_\_\_\_

## POST-INSTALLATION CHECKLIST

- Overnight leak down test — Recheck air pressure after the vehicle has been used for 24 hours. If the pressure has dropped more than 5 PSI, then there is a leak that must be fixed. Either fix the leak yourself or return to the installer for service.
- Air pressure requirements — Regardless of load, the air pressure should always be adjusted to maintain ride height at all times.
- Thirty day or 500 mile test — Recheck the air spring system after 30 days or 500 miles, whichever comes first. If any part shows signs of rubbing or abrasion, the source should be identified and moved, if possible. If it is not possible to relocate the cause of the abrasion, the air spring may need to be remounted. If professionally installed, the installer should be consulted. Check all fasteners for tightness.

# Product Use, Maintenance and Servicing

Minimum Recommended Pressure	Maximum Air Pressure
5 PSI	100 PSI

## MAINTENANCE GUIDELINES

### NOTE

*By following the steps below, vehicle owners will obtain the longest life and best results from their air springs.*

1. Check the air pressure weekly.
2. Always maintain normal ride height. Never inflate beyond 100 PSI.
3. If you develop an air leak in the system, use a soapy water solution (1/5 liquid dish soap and 4/5 water) to check all air line connections and the inflation valve core before deflating and removing the air spring.

### CAUTION

FOR YOUR SAFETY AND TO PREVENT POSSIBLE DAMAGE TO YOUR VEHICLE, DO NOT EXCEED MAXIMUM GROSS VEHICLE WEIGHT RATING (GVWR), AS INDICATED BY THE VEHICLE MANUFACTURER. ALTHOUGH YOUR AIR SPRINGS ARE RATED AT A MAXIMUM INFLATION PRESSURE OF 100 PSI, THE AIR PRESSURE ACTUALLY NEEDED IS DEPENDANT ON YOUR LOAD AND GVWR.

4. Loaded vehicles require at least 25 PSI or more. A “loaded vehicle” refers to a vehicle with a heavy bed load, a trailer, or both. As discussed above, never exceed GVWR, regardless of air spring, air pressure, or other load assist. The springs in this kit will support approximately 40 lbs. of load (combined on both springs) for each 1 PSI of pressure. The required air pressure will vary depending on the state of the original suspension. Operating the vehicle below the minimum air spring pressure will void the Air Lift warranty.
5. When increasing load, always adjust the air pressure to maintain the normal ride height. Increase or decrease pressure from the system as necessary to attain normal ride height for optimal ride and handling. Remember that loads carried behind the axle (including tongue loads) require more leveling force (pressure) than those carried directly over the axle.
6. Always add air to springs in small quantities, checking the pressure frequently.
7. Should it become necessary to raise the vehicle by the frame, make sure the system is at minimum pressure (5 PSI) to reduce the tension on the suspension/brake components. Use of on board leveling systems do not require deflation or disconnection.
8. Periodically check the air spring system fasteners for tightness. Also, check the air springs for any signs of rubbing. Realign if necessary.
9. On occasion, give the air springs a hard spray with a garden hose in order to remove mud, sand, gravel or other abrasive debris.

## TROUBLESHOOTING GUIDE

1. Leak test the air line connections, the threaded connection into the air spring, and all fittings in the control system.
2. Inspect the air lines to be sure none are pinched. Tie straps may be too tight. Loosen or replace the strap and replace leaking components.
3. Inspect the air line for holes and cracks. Replace as needed.
4. Look for a kink or fold in the air line. Reroute as needed.

If the preceding steps do not solve the problem, it is possibly caused by a failed air spring — either a factory defect or an operating problem. Please call Air Lift at (800) 248-0892 for assistance.

## FREQUENTLY ASKED QUESTIONS

**Q. Will installing air springs increase the weight ratings of a vehicle?**

No. Adding air springs will not change the weight ratings (GAWR, GCWR and/or GVWR) of a vehicle. Exceeding the GVWR is dangerous and voids the Air Lift warranty.

**Q. Is it necessary to keep air in the air springs at all times and how much pressure will they need?**

For LoadLifter 5000 Ultimate, the recommended minimum air pressure is 5 PSI, but it can safely be run at zero air pressure.

**Q. Is it necessary to add a compressor system to the air springs?**

No. Air pressure can be adjusted with any type of compressor as long as it can produce sufficient pressure to service the springs. Even a bicycle tire pump can be used, but it's a lot of work.

**Q. How long should air springs last?**

If the air springs are properly installed and maintained they can last indefinitely.

**Q. Will raising the vehicle on a hoist for service work damage the air springs?**

No. The vehicle can be lifted on a hoist for short-term service work such as tire rotation or oil changes. However, if the vehicle will be on the hoist for a prolonged period of time, support the axle with jack stands in order to take the tension off of the air springs.

## TUNING THE AIR PRESSURE

Pressure determination comes down to three things — level vehicle, ride comfort, and stability.

**1. Level vehicle**

If the vehicle's headlights are shining into the trees or the vehicle is leaning to one side, then it is not level (fig. 2.1). Raise the air pressure to correct either of these problems and level the vehicle.

**2. Ride comfort**

If the vehicle has a rough or harsh ride it may be due to either too much pressure or not enough (fig. 2.2). Try different pressures to determine the best ride comfort.

**3. Stability**

Stability translates into safety and should be the priority, meaning the driver may need to sacrifice a perfectly level and comfortable ride. Stability issues include roll control, bounce, dive during braking and sponginess (fig. 2.3). Tuning out these problems usually requires an increase in pressure.

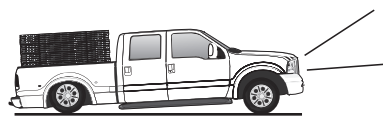

Bad headlight aim *fig. 2.1*



Rough ride *fig. 2.2*



Sway and body roll *fig. 2.3*

## GUIDELINES FOR ADDING AIR

1. Start with the vehicle level or slightly above.
2. When in doubt, always add air.
3. If the front of the vehicle dives while braking, increase the pressure in the front air bags, if equipped.
4. If it is ever suspected that the air bags have bottomed out, increase the pressure (fig. 2.4).
5. Adjust the pressure up and down to find the best ride.
6. If the vehicle rocks and rolls, adjust the air pressure to reduce movement.
7. It may be necessary to maintain different pressures on each side of the vehicle. Loads such as water, fuel, and appliances will cause the vehicle to be heavier on one side (fig. 2.5). As much as a 50 PSI difference is not uncommon.



Bottoming out

*fig. 2.4*

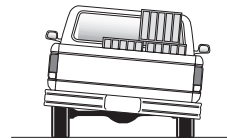

Unlevel

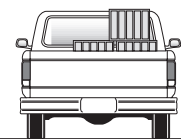

Level

*fig. 2.5*

# Choosing the Right On-Board Air Compressor System

**60 DAY** NO QUESTIONS ASKED, MONEY-BACK GUARANTEE

**TWO YEAR** COMPRESSOR SYSTEM WARRANTY

Add an on-board air compressor system to inflate and deflate your air springs with the touch of a button — from inside or outside of the vehicle.

- For convenient, on-the-go control of your air springs, add an Air Lift on-board air compressor system.
- Air Lift on-board air compressor systems eliminate the search for gas stations that have a working compressor, saving you time, energy and money.
- All systems include a compressor, controller and all parts needed for easy installation.

**1. Choose single or dual path inflation (see illustrations at right)**

**2. Choose wireless or analog control**

- **Wireless:** Control your air springs from inside or outside the vehicle. Easiest installation - no wires to the cab.
- **Analog:** In-cab control of your air springs. Economically priced.

**3. Choose heavy or standard duty compressor**

- **Standard duty:** A standard duty compressor will work well for most customers who use their system on an intermittent basis.
- **Heavy duty:** For daily use, consider the heavy duty compressor - it inflates faster and more quietly than the standard compressor.

Visit [www.airliftcompany.com](http://www.airliftcompany.com) for more detailed info on compressor systems.

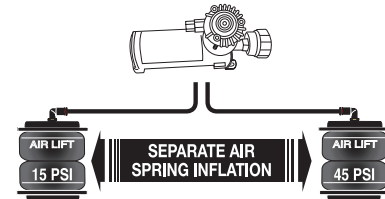

*Dual path systems* Air springs are controlled separately to allow for different air pressure from side-to-side. Perfect for uneven or top-heavy loads.

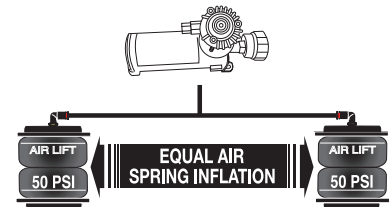

*Single path systems* Two springs will inflate at the same time. Good for loads that are evenly distributed from left-to-right or front-to-back.

W I R E L E S S

A N A L O G

DUAL PATH

**WirelessAIR™**

**PATENTED!**

- Easy installation
- Includes heavy duty compressor



P/N 72000

**LoadCONTROLLER™**

**Dual**

Compact, economically priced control.

**PATENT PENDING!**



P/N Standard Duty Compressor 25850; P/N Heavy Duty Compressor 25854

SINGLE PATH

**WirelessONE™**

**PATENTED!**

- Easy installation
- Includes standard duty compressor



P/N 25870

**LoadCONTROLLER™**

**Single**

Compact, economically priced control.

**PATENT PENDING!**



P/N Standard Duty Compressor 25852; P/N Heavy Duty Compressor 25856



# Notes



# Notes





# Notes



# Limited Warranty and Return Policy

## WHAT THIS WARRANTY COVERS

Air Lift Company provides a warranty to the original purchaser of its Load Support Products, for the periods of time listed below, by product line, from the date of original purchase, that the products will be free from defects in workmanship and materials when used on cars and trucks as specified by Air Lift Company and under normal operating conditions, subject to the requirements and exclusions set forth below.

## WHAT THIS WARRANTY DOES NOT COVER

The warranty does not apply to products that have been improperly applied, improperly installed, or which have not been maintained in accordance with installation instructions furnished with all products. This warranty does not apply and is void if damage or failure is caused by: accident, abuse, misuse (including but not limited to racing or off-road activities or commercial use), abnormal use, faulty installation, liquid contact, fire, earthquake or other external cause; operating the product outside Air Lift Company's instructions, specifications or guidelines; or service, alteration, maintenance or repairs performed by anyone other than Air Lift Company to the product from its purchased condition. This warranty also does not apply to: consumable parts, such as batteries; cosmetic damage, including but not limited to scratches or dents; defects caused by normal wear and tear or otherwise due to the normal aging of the product, or if any serial or identification number has been removed or defaced from the product. Air Lift Company reserves the right to change the design of any product without assuming any obligation to modify any product previously manufactured.

## LIMITATION OF LIABILITY

To the extent permitted by law, this warranty and the remedies set forth herein are exclusive and in lieu of all other warranties, remedies and conditions, whether oral, written, statutory, express or implied. AIR LIFT COMPANY DISCLAIMS ALL STATUTORY AND IMPLIED WARRANTIES, INCLUDING WITHOUT LIMITATION, WARRANTIES OF MERCHANTABILITY AND FITNESS FOR A PARTICULAR PURPOSE AND WARRANTIES AGAINST HIDDEN OR LATENT DEFECTS TO THE EXTENT PERMITTED BY LAW. To the extent such warranties cannot be disclaimed, such implied warranties shall apply only for the warranty period specified above. Please note that some states do not allow limitation on how long an implied warranty (or condition) lasts. So the above limitation may not apply to you.

Except as provided in this warranty and to the extent permitted by law, Air Lift Company shall not be liable for any direct, special, incidental or consequential damages resulting from any breach of warranty or condition, or arising in connection with the sale, use or repair of air lift products, or under any other legal theory, including but not limited to loss of use, loss of revenue, loss of actual or anticipated profits, loss of the use of money, loss of business, loss of opportunity, loss of goodwill, and loss of reputation. Air Lift Company's maximum liability shall not in any case exceed the purchase price paid by you for the Air Lift product. Please note that some states do not allow the exclusion or limitation of incidental or consequential damages, so the above limitation or exclusion may not apply to you.

## HOW TO GET SERVICE

If a defect in workmanship or materials causes your Air Lift product to become inoperable within the warranty period, before returning any defective product, call Air Lift Company at (800) 248-0892 in the U.S. and Canada (elsewhere, (517) 322-2144) to obtain a Returned Materials Authorization (RMA) number. The consumer shall be responsible for removing (labor charges) the defective product from the vehicle and returning it, shipping costs prepaid, to Air Lift Company for verification. Returns to Air Lift Company must be postage prepaid and sent to: Air Lift Company • 2727 Snow Road • Lansing, MI • 48917. You must prove to the satisfaction of Air Lift Company the date of original purchase of your Air Lift product. You must also enclose the RMA number and a return address. A minimum \$10 shipping and handling charge will apply to all warranty claims. You must also pack the product to minimize the risk of it being damaged in transit. If we receive a product in damaged condition as the result of shipping, we will notify you and you must seek a claim with the shipper.

## WHAT AIR LIFT COMPANY WILL DO

If you submit a valid claim to Air Lift Company during the warranty period, Air Lift Company will, at its option, repair your Air Lift product or furnish you with a new or rebuilt product. Air Lift Company will not reimburse you for repairs or replacement parts provided by other parties. Your repaired or replacement Air Lift product will be returned to you (subject to payment of the required warranty claim shipping and handling charge) and it will be covered under the warranty for the balance of the warranty period, if any. When a product or part is replaced, any replacement item becomes your property and the replaced item becomes property of Air Lift Company. You are responsible for installation/reinstallation (labor charges) of the product.

## HOW THE LAW RELATES TO THIS WARRANTY

This warranty gives you specific legal rights and you may also have other rights which vary from state to state. By this warranty, Air Lift Company does not limit or exclude your rights except as allowed by law. To fully understand your rights, you should consult the laws of your state.

## SPECIFIC LOAD SUPPORT WARRANTY PERIODS BY PRODUCT LINE

LoadLifter 5000™ Ultimate.....	Lifetime Limited	WirelessAIR™.....	2 Year Limited
LoadLifter 5000™.....	Lifetime Limited	WirelessONE™.....	2 Year Limited
RideControl™.....	Lifetime Limited	LoadController™ Single and Dual.....	2 Year Limited
Air Lift 1000™.....	Lifetime Limited	LoadController™ I and II.....	2 Year Limited
AirCell™.....	Lifetime Limited	SmartAir™ II.....	2 Year Limited
SlamAir™.....	Lifetime Limited	Other Accessories.....	2 Year Limited

# Replacement Part Information

If replacement parts are needed, contact the local dealer or call Air Lift customer service at **(800) 248-0892**. Most parts are immediately available and can be shipped the same day.

**Contact Air Lift Company customer service at (800) 248-0892 first if:**

- Parts are missing from the kit.
- Need technical assistance on installation or operation.
- Broken or defective parts in the kit.
- Wrong parts in the kit.
- Have a warranty claim or question.

**Contact the retailer where the kit was purchased:**

- If it is necessary to return or exchange the kit for any reason.
- If there is a problem with shipping if shipped from the retailer.
- If there is a problem with the price.

# Contact Information

<b>Mailing address</b>	P.O. Box 80167 Lansing, MI 48908-0167
<b>Shipping address for returns</b>	2727 Snow Road Lansing, MI 48917
<b>Phone</b>	Toll free: (800) 248-0892 International: (517) 322-2144
<b>Email</b>	service@airliftcompany.com
<b>Web address</b>	www.airliftcompany.com

## Need Help?

Contact our customer service department by calling (800) 248-0892, Monday through Friday. For calls from outside the USA or Canada, our local number is (517) 322-2144.

**Register your warranty online at  
[www.airliftcompany.com/warranty](http://www.airliftcompany.com/warranty)**



*Thank you for purchasing Air Lift products — the professional installer's choice!*

Air Lift Company • 2727 Snow Road • Lansing, MI 48917 or PO Box 80167 • Lansing, MI 48908-0167  
Toll Free (800) 248-0892 • Local (517) 322-2144 • Fax (517) 322-0240 • [www.airliftcompany.com](http://www.airliftcompany.com)

Printed in  
the USA